

34155 ✓ ACTIVE

PLASTI-GRIP

TE Internal #: 34155

Ring Terminals & Spade Terminals, Spade Tongue, 22 – 16 AWG

Wire Size, .26 – 1.65 mm<sup>2</sup> Wire Size, 509 – 3260 CMA Wire Size,

PLASTI-GRIP

[View on TE.com >](#)



Terminals & Splices > Ring Terminals & Spade Terminals

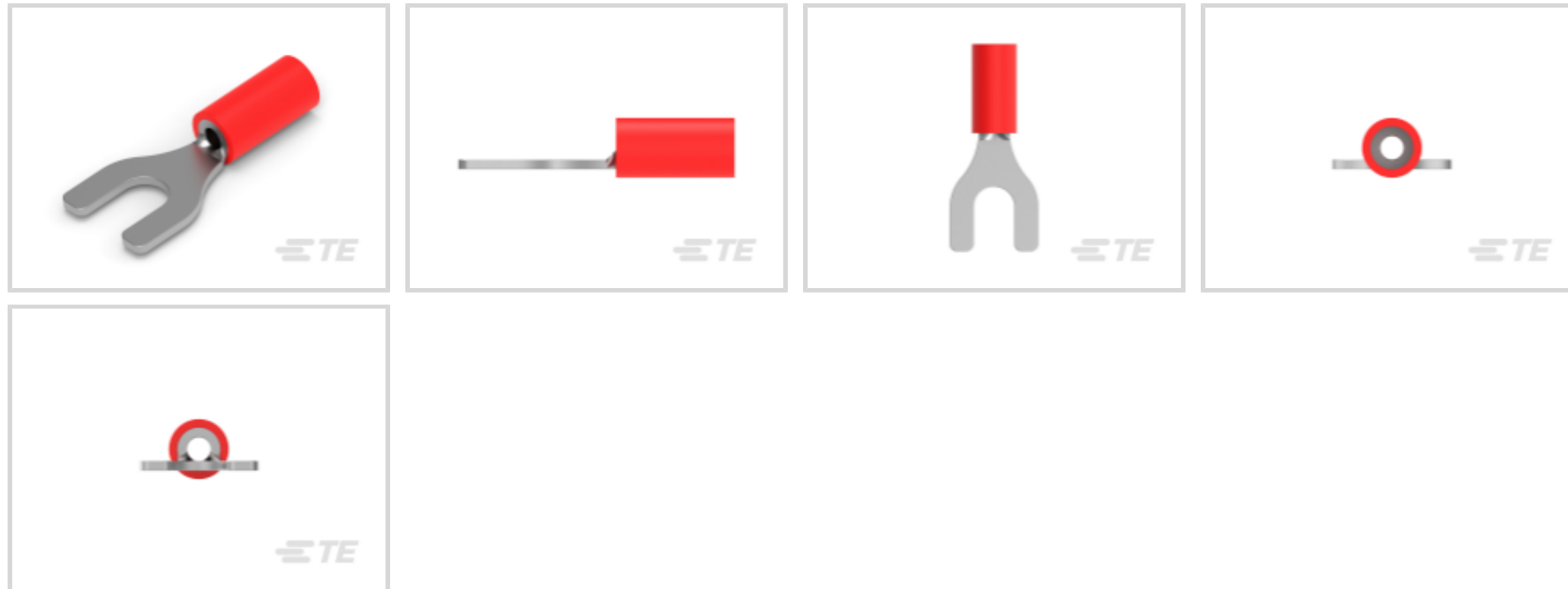

Ring & Spade Terminal Type: **Spade Tongue**

Wire Size: **509 – 3260 CMA**

Stud Size: **#8, M4**

### Features

#### Product Type Features

Stud Size	#8, M4
Sealable	No
Wire Insulation Support Retention Type	Insulation Support

#### Electrical Characteristics

Voltage Rating	600 V
----------------	-------

#### Body Features

Product Weight	.866 g
----------------	--------

#### Contact Features

Ring & Spade Terminal Type	Spade Tongue
Barrel Type	Closed
Terminal Orientation	Straight
Terminal Plating Material	Tin

#### Mechanical Attachment

Wire Insulation Support	With
-------------------------	------

#### Dimensions



Wire Size	509 – 3260 CMA
Stud Diameter	4.34 mm[.171 in]
Tongue Thickness	.79 mm[.031 in]
Product Length	23.37 mm[.92 in]
Compatible Insulation Diameter (Max)	3.56 mm[.14 in]
Compatible Insulation Diameter Range	2.67 – 3.56 mm[.105 – .14 in]

### Usage Conditions

Insulation Option	Partially Insulated
Operating Temperature Range	105 °C[221 °F]

### Operation/Application

Compatible With Wire Base Material	Copper
Compatible With Wire Plating Material	Tin

### Industry Standards

Government Qualified Terminal	No
-------------------------------	----

### Packaging Features

Packaging Quantity	1000
Packaging Method	Loose Piece

### Product Compliance

[For compliance documentation, visit the product page on TE.com>](#)

















EU RoHS Directive 2011/65/EU	Compliant
EU ELV Directive 2000/53/EC	Compliant
China RoHS 2 Directive MIIT Order No 32, 2016	No Restricted Materials Above Threshold
EU REACH Regulation (EC) No. 1907/2006	Current ECHA Candidate List: JAN 2023 (233) Candidate List Declared Against: JAN 2023 (233) Does not contain REACH SVHC
Halogen Content	Not Low Halogen - contains Br or Cl > 900 ppm.
Solder Process Capability	Not applicable for solder process capability

#### Product Compliance Disclaimer

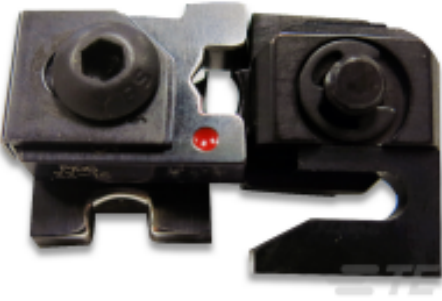
This information is provided based on reasonable inquiry of our suppliers and represents our current actual knowledge based on the information they provided. This information is subject to change. The part numbers that TE has identified as EU RoHS compliant have a maximum concentration of 0.1% by weight in homogenous materials for lead, hexavalent

chromium, mercury, PBB, PBDE, DBP, BBP, DEHP, DIBP, and 0.01% for cadmium, or qualify for an exemption to these limits as defined in the Annexes of Directive 2011/65/EU (RoHS2). Finished electrical and electronic equipment products will be CE marked as required by Directive 2011/65/EU. Components may not be CE marked. Additionally, the part numbers that TE has identified as EU ELV compliant have a maximum concentration of 0.1% by weight in homogenous materials for lead, hexavalent chromium, and mercury, and 0.01% for cadmium, or qualify for an exemption to these limits as defined in the Annexes of Directive 2000/53/EC (ELV). Regarding the REACH Regulation, the information TE provides on SVHC in articles for this part number is based on the latest European Chemicals Agency (ECHA) 'Guidance on requirements for substances in articles' posted at this URL: <https://echa.europa.eu/guidance-documents/guidance-on-reach>

## Compatible Parts

 <p>TE Part # 59824-1 TETRA-CRIMP PIDG PG FASTON 22-10 ASSY</p>	 <p>REPRESENTATION ONLY</p> <p>TE Part # 47386 DAHT PG PIDG 26-16 ASSY</p>	 <p>TE Part # 58433-3 PRO CR ASSY, RBY IS9252</p>	 <p>REPRESENTATION ONLY</p> <p>TE Part # 47386-4 DAHT PG PIDG 26-16 ASSY</p>
 <p>TE Part # 59250 T-HEAD PIDG 26-14 ASSY</p>	 <p>REPRESENTATION ONLY</p> <p>TE Part # 525690 DAHT PG PIDG 20-18 ASSY</p>	 <p>TE Part # 539691-2 ERGO DIE R.B.Y</p>	 <p>TE Part # 58423-1 DIE, RBY IS9252</p>
 <p>TE Part # 1-1377173-8 SMP 0-0034155-0</p>	 <p>TE Part # 2063030-1 SDE DIESET, RBY, UL</p>	 <p>TE Part # 47806-2 DIES PIDG 22-16 DIE SET</p>	 <p>TE Part # 59300 T-HEAD PIDG PG 26-16 ASSY</p>
 <p>TE Part # 169400 CERTI-LOK FRAME W/O DIES</p>	 <p>TE Part # 1SET191001R0000 CRIMP-HT</p>	 <p>TE Part # 1SET191002R0000 TET CRIMP-HT</p>	 <p>TE Part # 2392021-2 RED BATTERY DAHT KIT 220V (47689-4)</p>

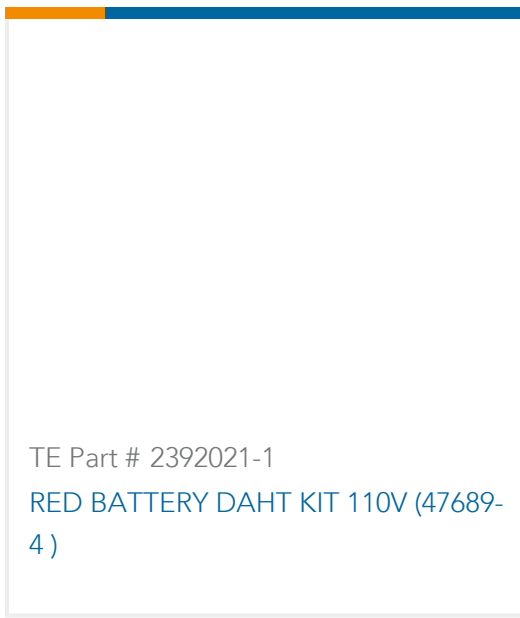

Also in the Series | **PLASTI-GRIP**

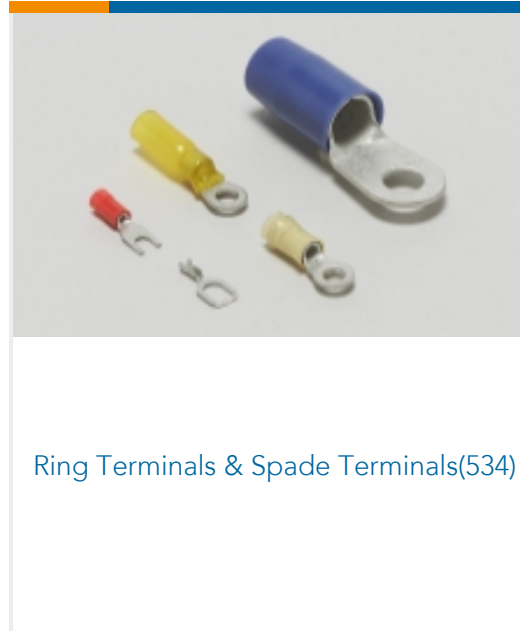
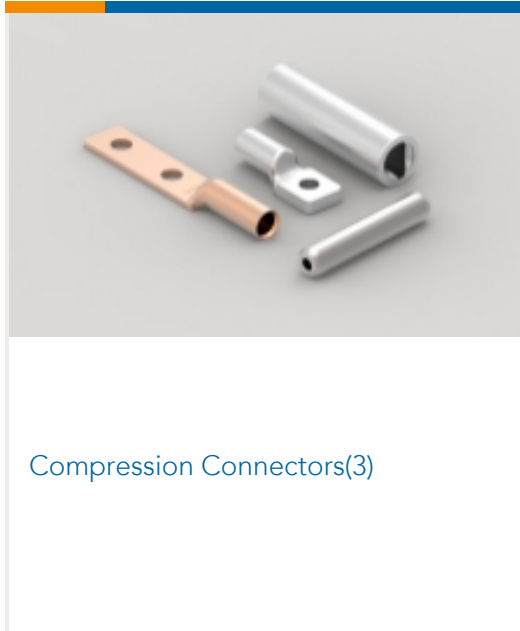

Customers Also Bought

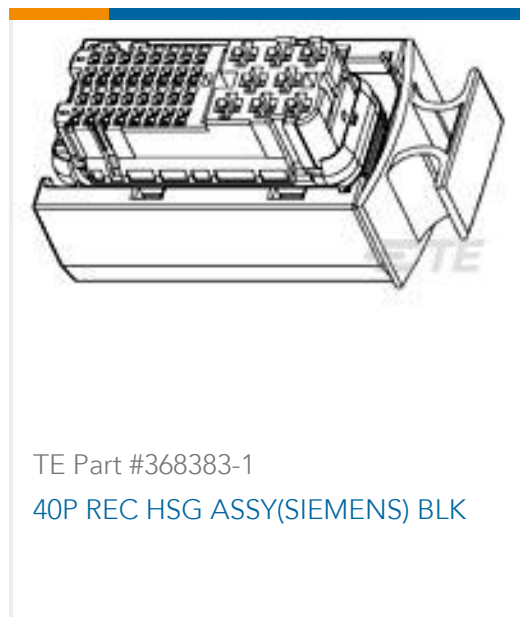
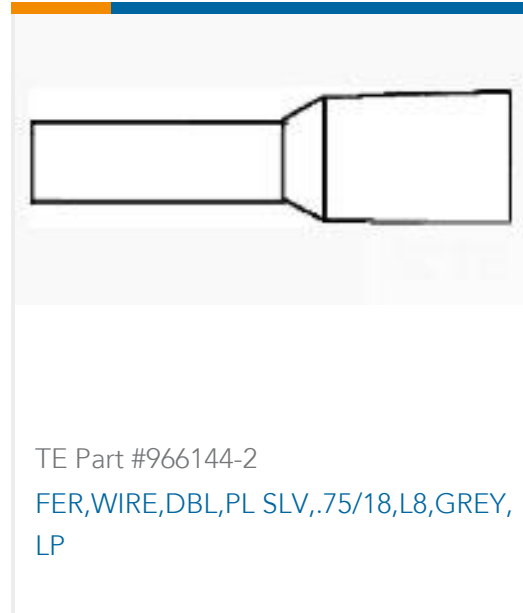



## Documents

### Product Drawings

[PG SPD 22-16 COMM 22-18 MIL 8](#)

English

---

### CAD Files

Customer View Model

[ENG\\_CVM\\_CVM\\_34155\\_P.2d\\_dxf.zip](#)

English

3D PDF

3D

Customer View Model

[ENG\\_CVM\\_CVM\\_34155\\_P.3d\\_igs.zip](#)

English

Customer View Model

[ENG\\_CVM\\_CVM\\_34155\\_P.3d\\_stp.zip](#)

English

By downloading the CAD file I accept and agree to the [Terms and Conditions](#) of use.

---

### Product Specifications

[Application Specification](#)

English

---

### Agency Approvals

[UL Report](#)

English

[UL Report](#)

English

[UL Report](#)

English

[UL Report](#)

English