

# Features

# Regulated Converters

- 2:1 wide input voltage range
- 1.6kVDC isolation
- UL60950-1 certified
- Efficiency up to 89%
- Six-sided continuous shield
- No minimum load required



## RP15-A

15 Watt  
1"x1"  
Single & Dual Output



### Description

The RP15-A series are ultraminiature power DC/DC converters in a case half the size of industry standard 15W converters. Despite their small size, the RP15-A converters are fully specified devices with output currents up to 4 Amps, no minimum load, 1600VDC isolation and low ripple/noise figures. The outputs are also fully protected against short circuits, overcurrent and overvoltage. The RP15-A series will find many uses in applications where board space and/or board height is at a premium.

### Selection Guide

Part Number	Input Voltage Range [VDC]	Output Voltage [VDC]	Output Current [mA]	Input Current [mA] <sup>(1)</sup>	Efficiency typ. [%] <sup>(1)</sup>	Max. Capacitive Load <sup>(2)</sup> [μF]
RP15-123.3SA <sup>(3,4)</sup>	9-18	3.3	4000	1310	84	12000
RP15-1205SA <sup>(3,4)</sup>	9-18	5	3000	1420	88	6000
RP15-1212SA <sup>(3,4)</sup>	9-18	12	1300	1512	86	1000
RP15-1215SA <sup>(3,4)</sup>	9-18	15	1000	1420	88	660
RP15-243.3SA <sup>(3,4)</sup>	18-36	3.3	4000	640	86	12000
RP15-2405SA <sup>(3,4)</sup>	18-36	5	3000	710	88	6000
RP15-2412SA <sup>(3,4)</sup>	18-36	12	1300	747	87	1000
RP15-2415SA <sup>(3,4)</sup>	18-36	15	1000	710	88	660
RP15-483.3SA <sup>(3,4)</sup>	36-75	3.3	4000	320	86	12000
RP15-4805SA <sup>(3,4)</sup>	36-75	5	3000	355	88	6000
RP15-4812SA <sup>(3,4)</sup>	36-75	12	1300	369	88	1000
RP15-4815SA <sup>(3,4)</sup>	36-75	15	1000	355	88	660
RP15-1205DA <sup>(3,4)</sup>	9-18	±5	±1500	1471	85	±3000
RP15-1212DA <sup>(3,4)</sup>	9-18	±12	±625	1437	87	±520
RP15-1215DA <sup>(3,4)</sup>	9-18	±15	±500	1420	88	±330
RP15-2405DA <sup>(3,4)</sup>	18-36	±5	±1500	735	85	±3000
RP15-2412DA <sup>(3,4)</sup>	18-36	±12	±625	710	88	±520
RP15-2415DA <sup>(3,4)</sup>	18-36	±15	±500	710	88	±330
RP15-4805DA <sup>(3,4)</sup>	36-75	±5	±1500	368	85	±3000
RP15-4812DA <sup>(3,4)</sup>	36-75	±12	±625	351	89	±520
RP15-4815DA <sup>(3,4)</sup>	36-75	±15	±500	355	88	±330

#### Notes:

- Note1: Measured at nominal input voltage and full load  
 Note2: Measured at minimum input voltage and constant resistive load



C **UL** US  
E196683

UL60950-1 Certified

### Model Numbering

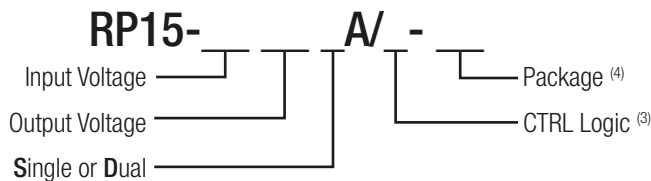

#### Ordering Examples

- RP15-2405SA/P = 24V Input, 5V Output, Positive Logic CTRL pin and Trim pin fitted  
 RP15-4805DA-HC = 48V Input, ±5V Output, Heat-sink fitted.

#### Notes:

- Note3: standard part is without suffix "P" or "N" = without CTRL & Trim function  
 Trim function is only available for single output with /P or /N suffix  
 add suffix "P" for CTRL function with positive logic (1=ON, 0=OFF) and trim pin for single output  
 add suffix "N" for CTRL function with negative logic (0=ON, 1=OFF) and trim pin for single output  
 Note4: add suffix -HC for premounted Heat-sink and clips

**Specifications** (measured at  $T_a = 25^\circ\text{C}$ , nominal input voltage, full load otherwise noted)

BASIC CHARACTERISTICS							
Parameter	Condition			Min.	Typ.	Max.	
Internal Input Filter				Pi-Type			
Input Voltage Range	nom. $V_{in} = 12\text{V}$ nom. $V_{in} = 24\text{V}$ nom. $V_{in} = 48\text{V}$			9VDC 18VDC 36VDC	12VDC 24VDC 48VDC	18VDC 36VDC 75VDC	
Input Surge Voltage	$V_{in} = 12\text{V}$ , 100ms max. $V_{in} = 24\text{V}$ , 100ms max. $V_{in} = 48\text{V}$ , 100ms max.					36VDC 50VDC 100VDC	
Under Voltage Lockout (UVLO)	$V_{in} = 12\text{V}$	DC-DC ON DC-DC OFF			8VDC	9VDC	
	$V_{in} = 24\text{V}$	DC-DC ON DC-DC OFF			14.5VDC	18VDC	
	$V_{in} = 48\text{V}$	DC-DC ON DC-DC OFF			30.5VDC	36VDC	
Input Reflected Ripple Current <sup>(5)</sup>					30mA <sub>p-p</sub>		
Output Voltage Trimming <sup>(6)</sup>	Single Output			±10.0%			
Minimum Load				0%			
Start-up time	Power up ON/OFF CTRL					30ms 30ms	
ON/OFF Control <sup>(7)</sup>	Positive Logic	DC-DC ON DC-DC OFF		Open or $3.0 < V_r < 15\text{VDC}$ Short or $0 < V_r < 1.2\text{VDC}$			
	Negative Logic	DC-DC ON DC-DC OFF		Short or $0 < V_r < 1.2\text{VDC}$ Open or $3.0 < V_r < 15\text{VDC}$			
Input Current of CTRL Pin	DC-DC ON			-0.5 mA		1.0mA	
Standby Current	DC-DC OFF				2.5mA		
Internal Operating Frequency				360kHz	400kHz	440kHz	
Ripple and Noise	measured by 20MHz bandwidth	with a 1 $\mu\text{F}$ M/C X7R and 10 $\mu\text{F}$ T/C	Single	3.3V <sub>out</sub> , 5V <sub>out</sub> 12V <sub>out</sub> , 15V <sub>out</sub>		75mV <sub>p-p</sub> 100mV <sub>p-p</sub> 100mV <sub>p-p</sub>	
		with a 1 $\mu\text{F}$ M/C X7R and 10 $\mu\text{F}$ T/C					Dual
		with a 1 $\mu\text{F}$ M/C X7R and 10 $\mu\text{F}$ T/C					

**Notes:**

Note5: Simulated source impedance of 12 $\mu\text{H}$ . 12 $\mu\text{H}$  inductor in series with + $V_{in}$

Note6: Trimming allows the user to increase or decrease the output voltage set point of the module. This is accomplished by connecting an external resistor between the Trim pin and either + $V_{out}$  pin or - $V_{out}$  pin

Note7: The ON/OFF control function can be positive or negative logic. The pin voltage is referenced to - $V_{in}$  pin. If no suffix is specified, the control pin will be omitted

**RP15-1205SA**

**Efficiency vs. Output Current**

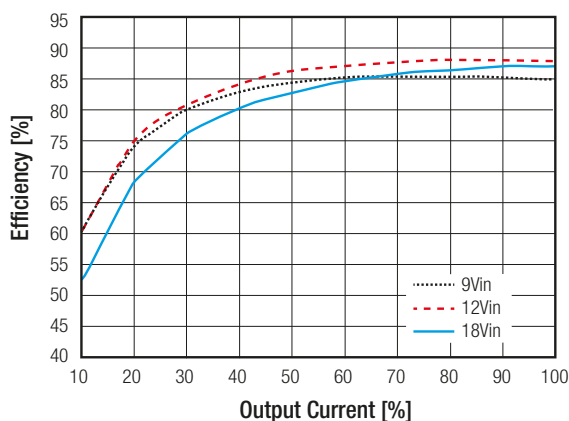

**Efficiency vs. Input Voltage**

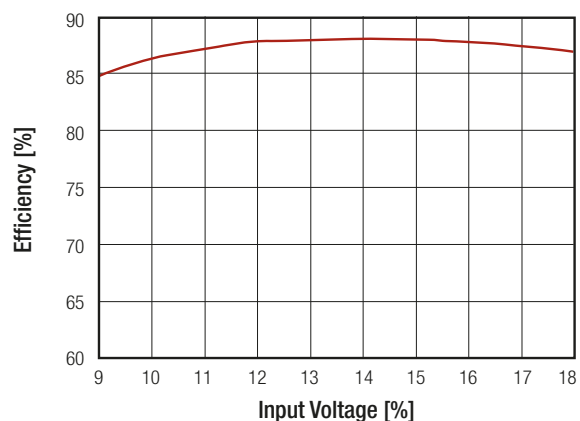

continued on next page

Specifications (measured at  $T_a = 25^\circ\text{C}$ , nominal input voltage, full load otherwise noted)

**RP15-2405SA**

Efficiency vs. Output Current

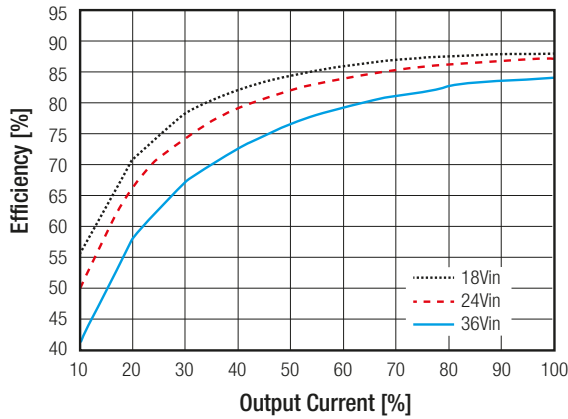

Efficiency vs. Input Voltage

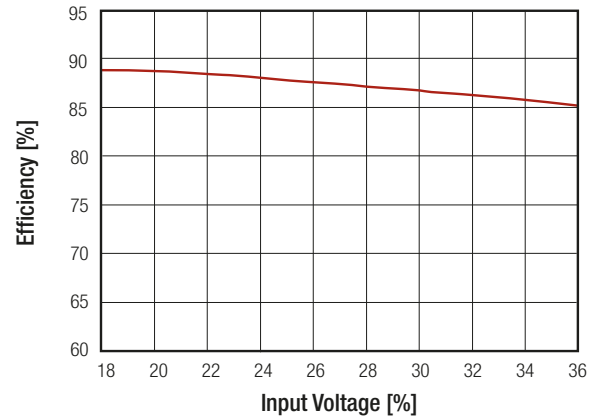

**RP15-4805SA**

Efficiency vs. Output Current

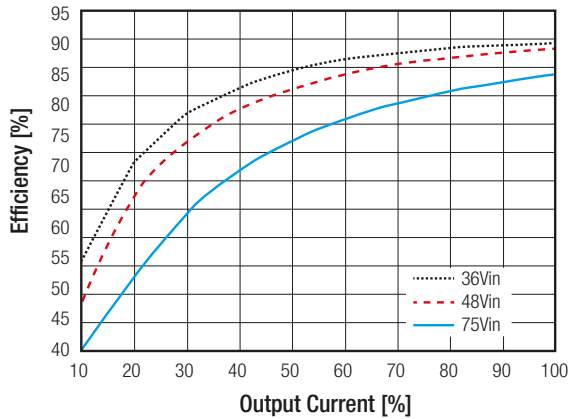

Efficiency vs. Input Voltage

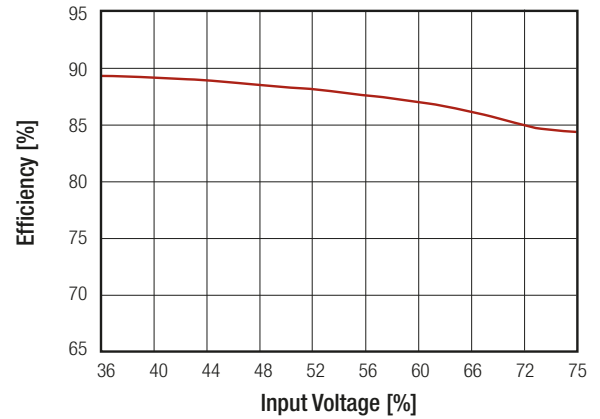

**External Output Trimming**

**Output Voltage Trimming**

Single output Powerline converters offer the feature of trimming the output voltage over a certain range around the nominal value by using external trim resistors. No general equation can be given for calculating the trim resistors, but the following trimtables give typical values for choosing these trimming resistors. If voltages between the given trim points are required, extrapolate between the two nearest given values to work out the resistor required or use a variable resistor to set the output voltage.

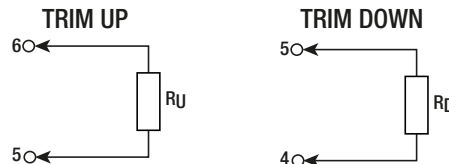

**RP15-xx3.3A**

Trim up	1	2	3	4	5	6	7	8	9	10	%
Vout =	3.333	3.366	3.399	3.432	3.465	3.498	3.531	3.564	3.597	3.63	Volts
$R_u =$	385.071	191.511	126.990	94.730	75.374	62.470	53.253	46.340	40.963	36.662	kOhms
Trim down	1	2	3	4	5	6	7	8	9	10	%
Vout =	3.267	3.234	3.201	3.168	3.135	3.102	3.069	3.036	3.003	2.97	Volts
$R_d =$	116.719	54.779	34.133	23.810	17.616	13.486	10.537	8.325	6.604	5.228	kOhms

continued on next page

**Specifications** (measured at  $T_a = 25^\circ\text{C}$ , nominal input voltage, full load otherwise noted)

RP15-xx05A											
Trim up	1	2	3	4	5	6	7	8	9	10	%
Vout =	5.05	5.10	5.15	5.20	5.25	5.30	5.35	5.4	5.45	5.50	Volts
$R_{\text{L}}$ =	253.450	125.700	83.117	61.825	49.050	40.533	34.450	29.888	26.339	23.500	kOhms
Trim down	1	2	3	4	5	6	7	8	9	10	%
Vout =	4.95	4.90	4.85	4.80	4.75	4.70	4.65	4.60	4.55	4.50	Volts
$R_{\text{D}}$ =	248.340	120.590	78.007	56.715	43.940	35.423	29.340	24.778	21.229	18.390	kOhms
RP15-xx12A											
Trim up	1	2	3	4	5	6	7	8	9	10	%
Vout =	12.12	12.24	12.36	12.48	12.60	12.72	12.84	12.96	13.08	13.20	Volts
$R_{\text{L}}$ =	203.223	99.057	64.334	46.973	36.557	29.612	24.652	20.932	18.038	15.723	kOhms
Trim down	1	2	3	4	5	6	7	8	9	10	%
Vout =	11.88	11.76	11.64	11.52	11.40	11.28	11.16	11.04	10.92	10.8	Volts
$R_{\text{D}}$ =	776.557	308.723	248.779	182.807	143.223	116.834	97.985	83.848	72.853	64.057	kOhms
RP15-xx15A											
Trim up	1	2	3	4	5	6	7	8	9	10	%
Vout =	15.15	15.3	15.45	15.60	15.75	15.90	16.05	16.20	16.35	16.50	Volts
$R_{\text{L}}$ =	161.557	78.223	50.446	36.557	28.223	22.668	18.700	15.723	13.409	11.557	kOhms
Trim down	1	2	3	4	5	6	7	8	9	10	%
Vout =	14.85	14.70	14.55	14.40	14.25	14.10	13.95	13.80	13.65	13.50	Volts
$R_{\text{D}}$ =	818.223	401.557	262.668	193.223	151.557	123.779	103.938	89.057	77.483	68.223	kOhms

REGULATIONS		
Parameter	Condition	Value
Output Voltage Accuracy		$\pm 1.0\%$
Line Voltage Regulation	Single	$\pm 0.2\%$
	Dual	$\pm 0.5\%$
Load Voltage Regulation	0% to 100% load	$\pm 0.2\%$
	Single Dual	$\pm 1.0\%$
Cross Regulation	asymmetrical 25% $\leftrightarrow$ 100% load	$\pm 5.0\%$
Transient Response	25% load step change	recovery time
		250 $\mu\text{s}$ typ.

**Specifications** (measured at Ta = 25°C, nominal input voltage, full load otherwise noted)

PROTECTIONS			
Parameter	Condition		Value
Short Circuit Protection (SCP)			continuous, automatic recovery
Over Voltage Protection (OVP)	Zener Diode Clamp	3.3Vout	3.7 - 5.4VDC
		5Vout	5.6 - 7.0VDC
		12Vout	13.5 - 19.6VDC
		15Vout	16.8 - 20.5VDC
Over Load Protection (OLP)			Hiccup mode, 150% of rated lout typ.
Isolation Voltage	tested for 1 minute	I/P to O/P	1.6kVDC
		I/P (O/P) to case	1.0kVDC
Isolation Resistance	tested with 500VDC		1GΩ min.
Isolation Capacitance			1000pF max.
<b>Notes:</b>			
Note8: This power module is not internally fused. An input line fuse must always be used. Recom suggests: 12Vin= T3.15A; 24Vin= T1.6A; 48Vin= T1.25A slow blow types			

ENVIRONMENTAL			
Parameter	Condition		Value
Operating Temperature Range	without derating		-40°C to +68°C
	with derating		-40°C to +105°C
Maximum Case Temperature			+105°C
Temperature Coefficient			±0.02%/°C max.
Thermal Impedance	natural convection 0.1m/s (20LFM)	without Heat-sink	18.2°C/Watt
		with Heat-sink	15.8°C/Watt
Operating Humidity			5% - 95% RH
Thermal Shock			according to MIL-STD-810F
Vibration			according to MIL-STD-810F
MTBF	according to MIL-HDBK-217F, G.B. Bellcore TR-NWT-000332 (8)	+25°C	1600 x 10 <sup>3</sup> hours
			1330 x 10 <sup>3</sup> hours

**Derating Graph (10)**

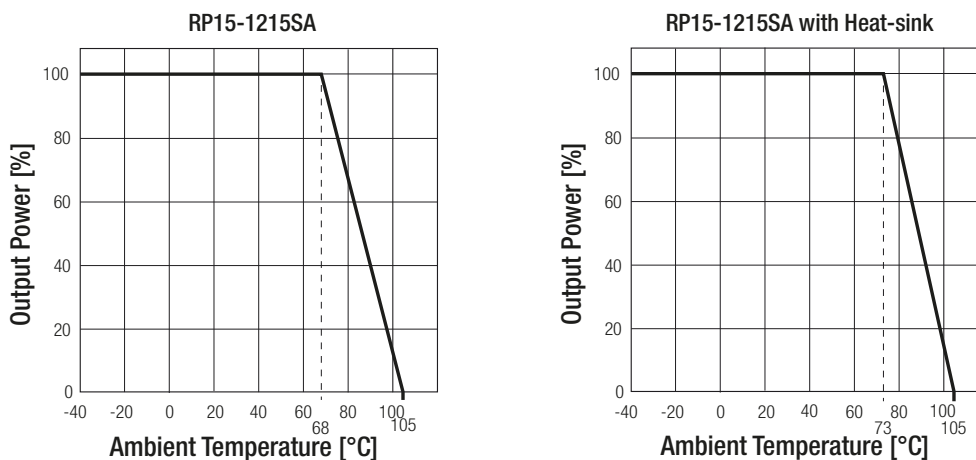

**Notes:**

Note9: BELLCORE TR-NWT-000332. Case I: 50% Stress, Ta= 40°C. MIL-HDBK 217F Notice 2. Ta = 25°C, full load, (controlled environment)

Note10: Derating graphs are valid only for the shown part numbers. If you need detailed derating-information about a part number not shown here please contact our technical support service at techsupportAT@recom-power.com

**Specifications** (measured at  $T_a = 25^\circ\text{C}$ , nominal input voltage, full load otherwise noted)

### SAFETY AND CERTIFICATIONS

Certificate Type (Safety)	Report / File Number	Standard
Information Technology Equipment, General Requirements for Safety	E196683	UL60950-1 1st. Ed.: 2003 C22.2 No. 60950 1st. Ed.: 2003
EMC Compliance	Condition	Standard / Criterion
Information technology equipment - Radio disturbance characteristics - Limits and methods of measurement	with external filter	EN55022, Class A or B
ESD Electrostatic discharge immunity test	Air $\pm 8\text{kV}$ and Contact $\pm 6\text{kV}$	EN61000-4-2, Criteria A
Radiated, radio-frequency, electromagnetic field immunity test	10V/m	EN61000-4-3, Criteria A
Fast Transient and Burst Immunity <sup>(1)</sup>	$\pm 2\text{kV}$	EN61000-4-4, Criteria A
Surge Immunity <sup>(1)</sup>	$\pm 1\text{kV}$	EN61000-4-5, Criteria A
Immunity to conducted disturbances, induced by radio-frequency fields	10Vr.m.s	EN61000-4-6, Criteria A

#### Notes:

Note11: An external input filter capacitor is required if the module has to meet EN61000-4-4, EN61000-4-5. The filter capacitor Recom suggests: Nippon chemi-con KY series, 220 $\mu\text{F}/100\text{V}$

#### EMI Filtering Class A

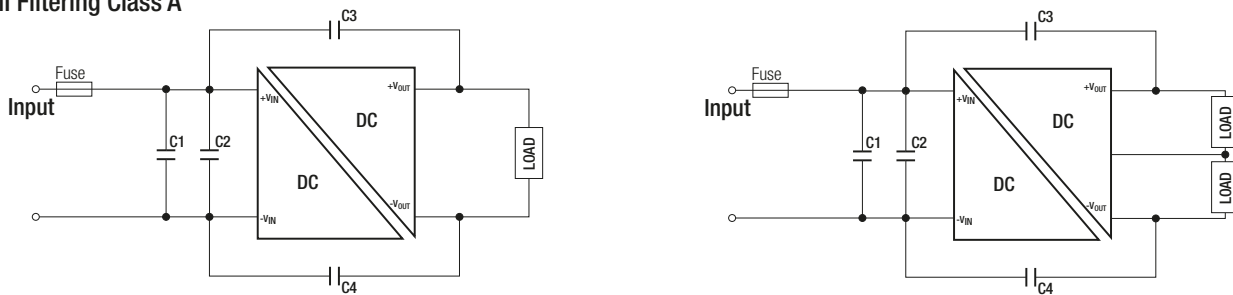

MODEL	C1	C2	C3/C4
RP15-12xxS_DA	10 $\mu\text{F}/25\text{V}$ 1812 MLCC	N/A	470pF/2kV 1808 MLCC
RP15-24xxS_DA	6.8 $\mu\text{F}/50\text{V}$ 1812 MLCC	6.8 $\mu\text{F}/50\text{V}$ 1812 MLCC	470pF/2kV 1808 MLCC
RP15-48xxS_DA	2.2 $\mu\text{F}/100\text{V}$ 1812 MLCC	2.2 $\mu\text{F}/100\text{V}$ 1812 MLCC	470pF/2kV 1808 MLCC

#### EMI Filtering Class B

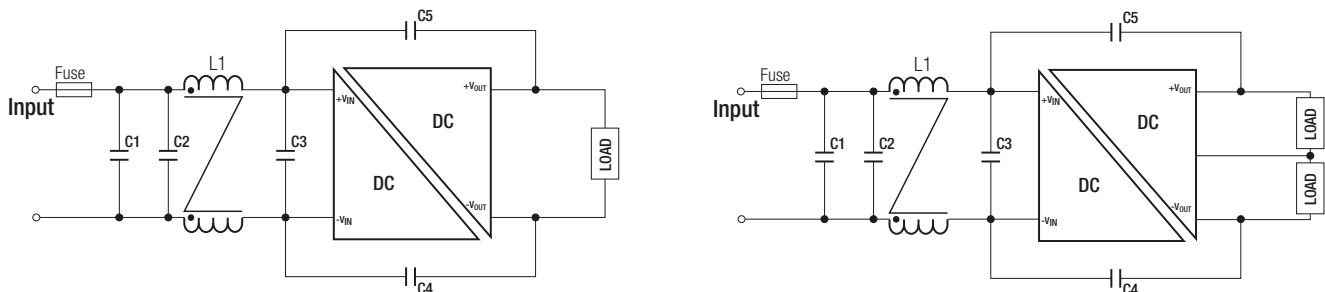

MODEL	C1	C2	C3	C4/C5	L1
RP15-12xxS_DA	10 $\mu\text{F}/25\text{V}$ 1812 MLCC	N/A	10 $\mu\text{F}/25\text{V}$ 1812 MLCC	470pF/2kV 1808 MLCC	CMC: 145 $\mu\text{H}$ ref: WE 482210002 ref: CMC-07
RP15-24xxS_DA	6.8 $\mu\text{F}/50\text{V}$ 1812 MLCC	N/A	6.8 $\mu\text{F}/50\text{V}$ 1812 MLCC	470pF/2kV 1808 MLCC	CMC: 325 $\mu\text{H}$ ref: WE 744290321 ref: CMC-06
RP15-48xxS_DA	2.2 $\mu\text{F}/100\text{V}$ 1812 MLCC	2.2 $\mu\text{F}/100\text{V}$ 1812 MLCC	2.2 $\mu\text{F}/100\text{V}$ 1812 MLCC	470pF/2kV 1808 MLCC	CMC: 325 $\mu\text{H}$ ref: WE 744290321 ref: CMC-06

**Specifications** (measured at Ta = 25°C, nominal input voltage, full load otherwise noted)

**DIMENSIONS and PHYSICAL CHARACTERISTICS**

Parameter	Type	Value
Material	Case	Nickel coated copper
	Base	FR4 PCB
	Potting	Epoxy (UL94-V0)
Package Dimensions (LxWxH)	without Heat-sink	25.4 x 25.4 x 9.9mm
	with Heat-sink	31.4 x 25.4 x 16.5mm
Package Weight	without Heat-sink	15g
	with Heat-sink	21.5g

**Dimension Drawing (mm)**

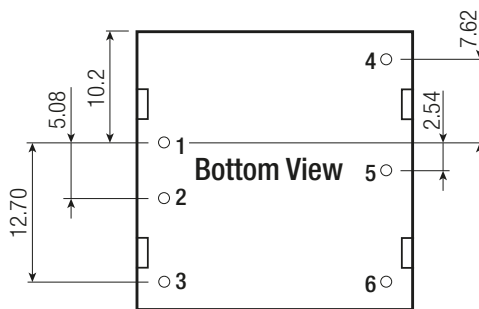
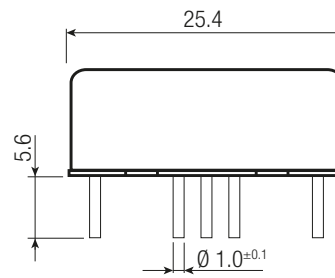
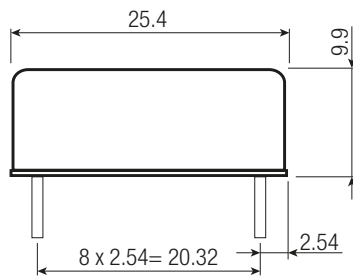
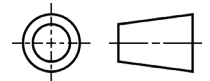

**Recommended Footprint Details**

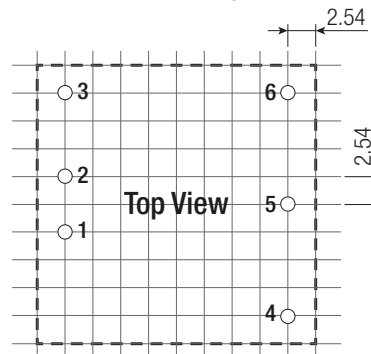

**Pin Connections**

Pin #	Single	Single /P or /N	Dual	Dual /P or /N
1	+Vin	+Vin	+Vin	+Vin
2	-Vin	-Vin	-Vin	-Vin
3	no Pin	CTRL	no Pin	CTRL
4	+Vout	+Vout	+Vout	+Vout
5	no Pin	Trim	Com	Com
6	-Vout	-Vout	-Vout	-Vout

Pin Pitch Tolerance ±0.25mm  
 Pin Dimension Tolerance ±0.1mm  
 XX.X ± 0.5 mm  
 XX.XX ± 0.25 mm

continued on next page

**Specifications** (measured at Ta = 25°C, nominal input voltage, full load otherwise noted)

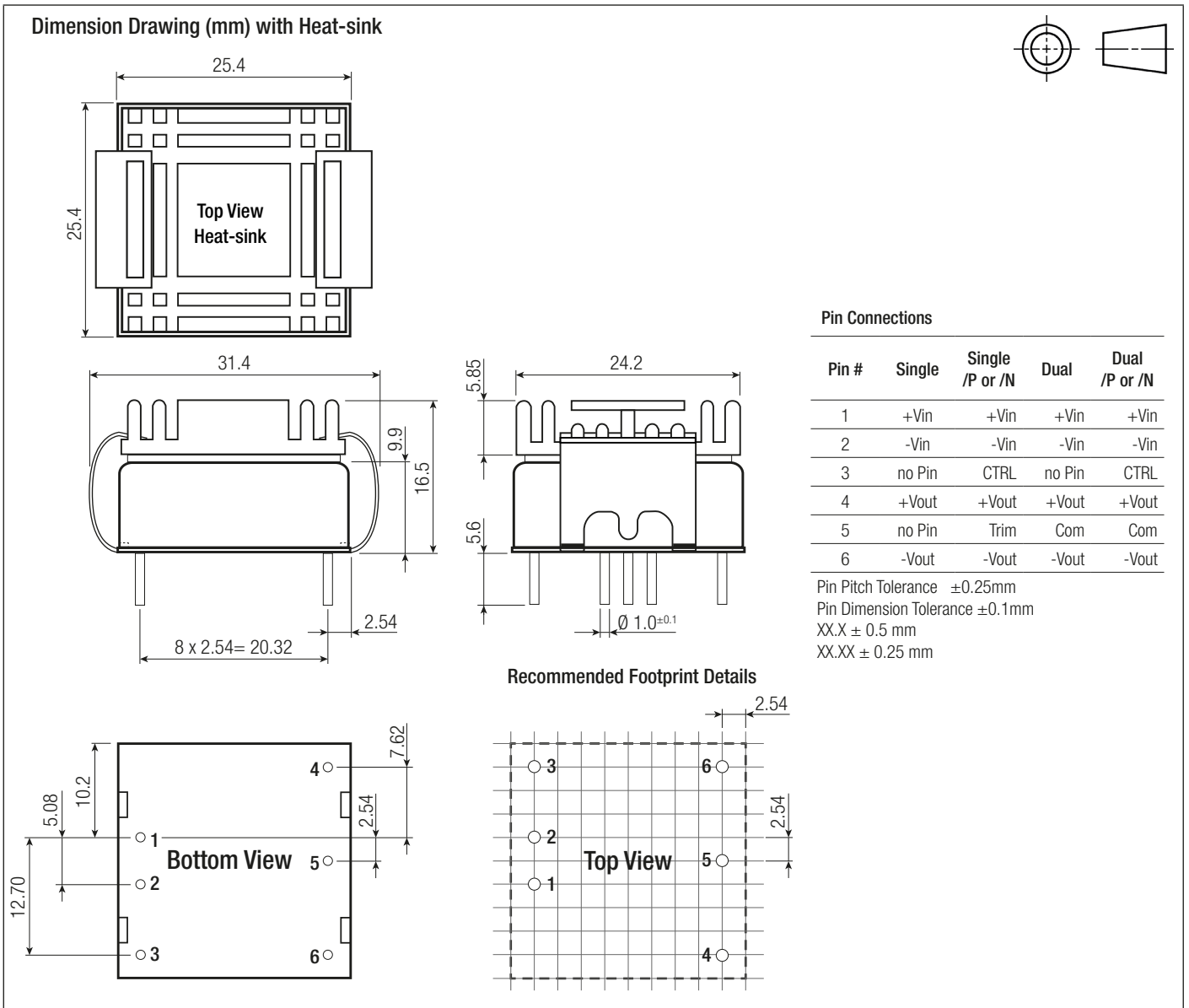

**PACKAGING INFORMATION**

Parameter	Type	Value
Packaging Dimensions (LxWxH)	without Heat-sink	Tube 257.0 x 26.5 x 19.0mm
	with Heat-sink	Tray 230.0 x 180.0 x 28.0mm
Packaging Quantity	without Heat-sink	Tube 8pcs
	with Heat-sink	Tray 20pcs
Storage Temperature Range		-55°C to +125°C
Storage Humidity		5% - 95% RH

The product information and specifications may be subject to changes even without prior written notice. The product has been designed for various applications; its suitability lies in the responsibility of each customer. The products are not authorized for use in safety-critical applications without RECOM's explicit written consent. A safety-critical application is an application where a failure may reasonably be expected to endanger or cause loss of life, inflict bodily harm or damage property. The applicant shall indemnify and hold harmless RECOM, its affiliated companies and its representatives against any damage claims in connection with the unauthorized use of RECOM products in such safety-critical applications.