

## 500 WATT ULTRA LOW CAPACITANCE TVS ARRAY



**SOT-23 PACKAGE**

### DESCRIPTION

The PSOTxxLC series are ultra low capacitance transient voltage suppressor (TVS) arrays, designed for power or data line applications that provide protection against ESD, tertiary lightning and switching transients. This series offers low clamping voltage for the protection of sensitive components.

The PSOTxxLC series has a peak pulse power of 500 Watts for an 8/20 $\mu$ s waveshape and is available in a SOT-23 package configuration. This series meets the IEC 61000-4-2, 61000-4-4 and IEC 61000-4-5 requirements.

### FEATURES

- Compatible with IEC 61000-4-2 (ESD): Air 15kV, Contact 8kV
- Compatible with IEC 61000-4-4 (EFT): 40A, 5/50ns
- Compatible with IEC 61000-4-5 (Surge): 12A, 8/20 $\mu$ s - Level 1(Line-Ground) & Level 2(Line-Line)
- 500 Watts Peak Pulse Power per Line(tp = 8/20 $\mu$ s)
- Low Clamping Voltage
- Ultra Low Capacitance
- Available in Multiple Voltages Ranging from 3V to 36V
- RoHS Compliant
- REACH Compliant

### APPLICATIONS

- Ethernet 10/100 Base T
- Cellular Phones
- FireWire
- Audio/Video Inputs
- Portable Electronics

### MECHANICAL CHARACTERISTICS

- Molded JEDEC SOT-23 Package
- Approximate Weight: 8 milligrams
- Lead-Free Pure-Tin Plating (Annealed)
- Solder Reflow Temperature:  
Pure-Tin - Sn, 100: 260-270°C
- Flammability Rating UL 94V-0
- 8mm Tape and Reel per EIA Standard 481

### PIN CONFIGURATION

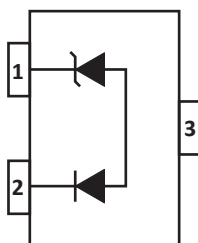

**TYPICAL DEVICE CHARACTERISTICS**
**MAXIMUM RATINGS @ 25°C Unless Otherwise Specified**

PARAMETER	SYMBOL	VALUE	UNITS
Peak Pulse Power (tp = 8/20μs) - See Figure 1	P <sub>PP</sub>	500	Watts
Operating Temperature	T <sub>L</sub>	-55 to 150	°C
Storage Temperature	T <sub>STG</sub>	-55 to 150	°C

**ELECTRICAL CHARACTERISTICS PER LINE @ 25°C Unless Otherwise Specified**

PART NUMBER (Note 1)	DEVICE MARKING	RATED STAND-OFF VOLTAGE  V <sub>WM</sub> VOLTS	MINIMUM BREAKDOWN VOLTAGE (Note 2) @ 1mA V <sub>(BR)</sub> VOLTS	MAXIMUM CLAMPING VOLTAGE (Fig. 2) @ I <sub>p</sub> = 1A V <sub>C</sub> VOLTS	MAXIMUM CLAMPING VOLTAGE (Fig. 2) @ I <sub>p</sub> = 5A V <sub>C</sub> VOLTS	MAXIMUM LEAKAGE CURRENT  @V <sub>WM</sub> I <sub>D</sub> μA	TYPICAL CAPACITANCE  @0V, 1MHz C pF
PSOT03LC	03L	3.3	4.0	7.0	9.0	125	5
PSOT05LC	05L	5.0	6.0	9.8	11.0	20	5
PSOT08LC	08L	8.0	8.5	13.4	15.0	10	5
PSOT12LC	12L	12.0	13.3	19.0	23.0	1	5
PSOT15LC	15L	15.0	16.7	24.0	28.0	1	5
PSOT24LC	24L	24.0	26.7	43.0	46.0	1	5
PSOT36LC	36L	36.0	40.0	51.0	68.0	1	5

**NOTES**

1. Positive potential is applied from pin 1 to 2; pin 2 is ground.
2. Do not test or surge from pin 2 to 1. PIV typically greater than 100V for rectifier diode.

TYPICAL DEVICE CHARACTERISTICS

FIGURE 1  
PEAK PULSE POWER VS PULSE TIME

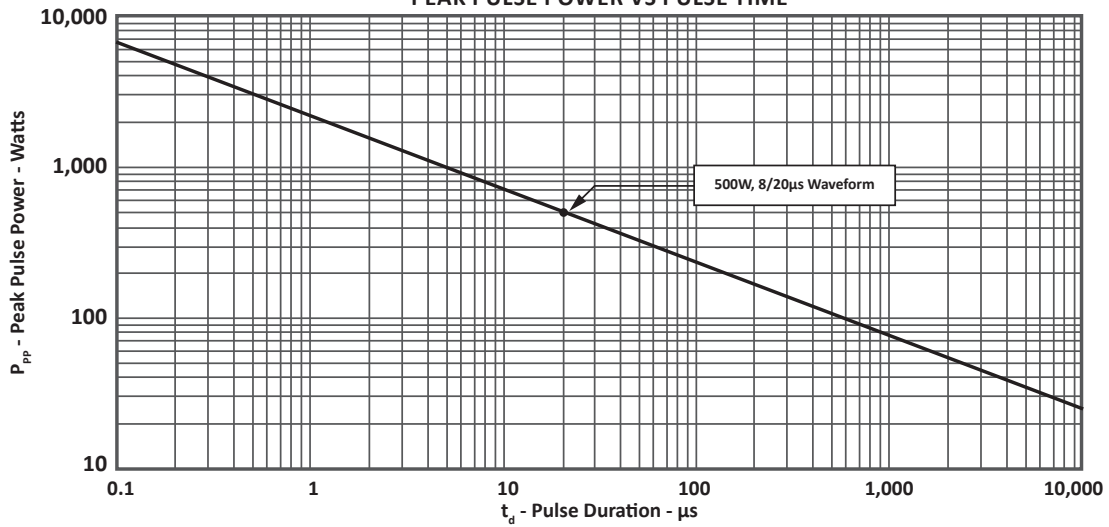

FIGURE 2  
PULSE WAVE FORM

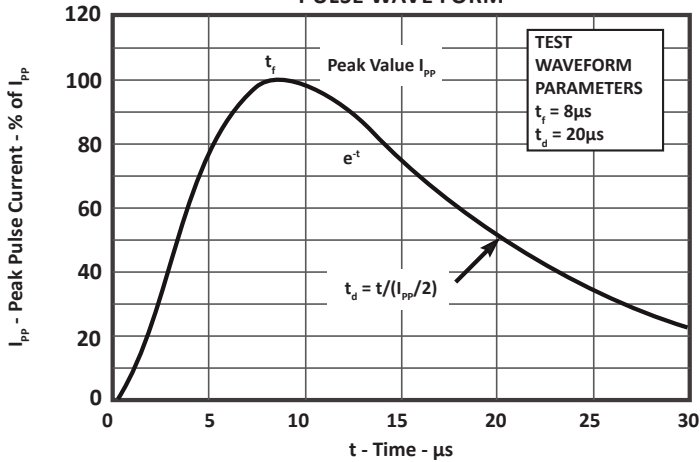
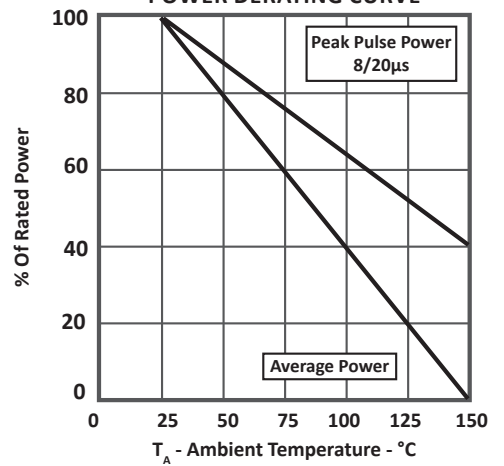
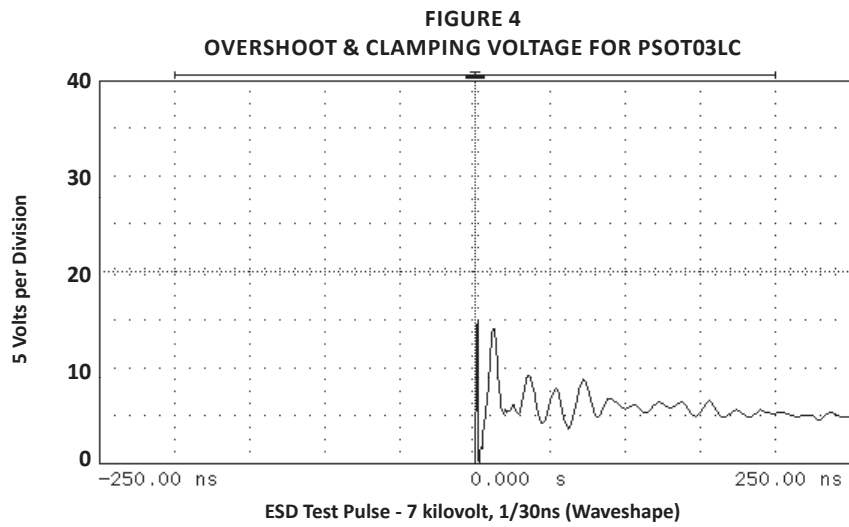

FIGURE 3  
POWER DERATING CURVE



## TYPICAL DEVICE CHARACTERISTICS



## SPICE MODEL

FIGURE 1  
SPICE MODEL FOR



ABD - Avalanche Breakdown Diode (TVS)  
 LCRD - Low Capacitance Rectifier Diode  
 Lg - Lead Inductance

TABLE 1 - SPICE PARAMETERS

PARAMETER	UNIT	ABD(TVS)	LCRD
BV	V	See Table 2	200
IBV	$\mu\text{A}$	1	0.01
$C_{jo}$	pF	See Table 2	5
$I_s$	A	See Table 2	1E-14
Vj	V	0.6	0.6
M	-	0.33	0.33
N	-	1	1
$R_s$	Ohms	See Table 2	0.31
TT	s	1E-8	1E-9
EG	eV	1.11	1.11

TABLE 2 - ABD SPECIFIC SPICE PARAMETERS

PART NUMBER	$B_v$ (VOLTS)	$C_{jo}$ (pF)	$I_s$ (AMPS)	$R_s$ (OHMS)
PSOT03LC	4.5	438	1E-11	0.21
PSOT05LC	6.0	284	1E-11	0.14
PSOT08LC	8.5	146	1E-11	0.28
PSOT12LC	13.3	123	1E-13	0.40
PSOT15LC	16.7	102	1E-13	0.52
PSOT12LC	26.7	61	1E-13	1.54

## APPLICATION INFORMATION

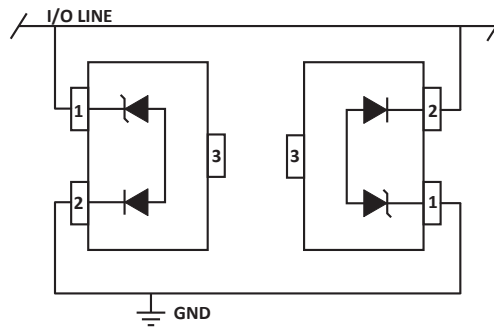

**FIGURE 1 - COMMON MODE I/O PORT PROTECTION**

Two PSOTxxLC devices used in parallel. Circuit connectivity is as follows:

- I/O Line connected to Device 1, Pin 1.
- I/O Line connected to Device 2, Pin 2.
- Device 1, Pin 2 connected to ground.
- Device 2, Pin 1 connected to ground.
- Device 1 and 2, Pin 3 not connected.

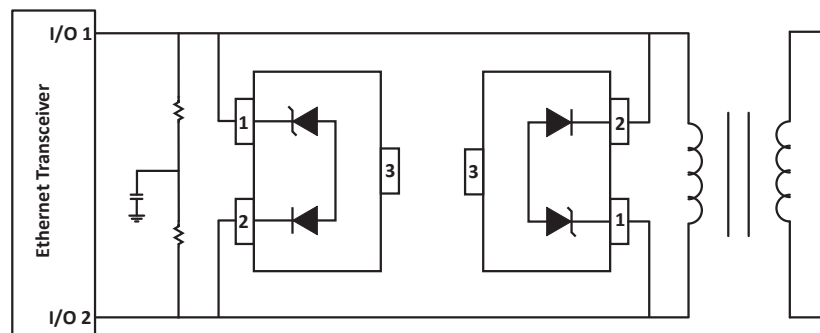

**FIGURE 1 - DIFFERENTIAL MODE ETHERNET PROTECTION**

Two PSOTxxLC devices used in parallel. Circuit connectivity is as follows:

- I/O Line 1 connected to Device 1, Pin 1.
- I/O Line 1 connected to Device 2, Pin 2.
- I/O Line 2 connected to Device 1, Pin 2.
- I/O Line 2 connected to Device 2, Pin 1.
- Device 1 and 2, Pin 3 not connected.

## CIRCUIT BOARD RECOMMENDATIONS

Circuit board layout is critical for electromagnetic compatibility protection. The following guidelines are recommended:

- The protection device should be placed near the input terminals or connectors, the device will divert the transient current immediately before it can be coupled into the nearby traces.
- The path length between the TVS device and the protected line should be minimized.
- All conductive loops including power and ground loops should be minimized.
- The transient current return path to ground should be kept as short as possible to reduce parasitic inductance.
- Ground planes should be used whenever possible. For multilayer PCBs, use dedicated ground planes

## SOT-23 PACKAGE INFORMATION

## OUTLINE DIMENSIONS

DIM	MILLIMETERS		INCHES	
	MIN	MAX	MIN	MAX
A	2.80	3.04	0.110	0.120
B	1.20	1.40	0.047	0.055
C	0.89	1.11	0.035	0.044
D	0.37	0.50	0.015	0.020
G	1.78	2.04	0.070	0.081
H	0.013	0.100	0.001	0.004
J	0.085	0.177	0.003	0.007
K	0.45	0.60	0.018	0.024
L	0.89	1.02	0.035	0.040
S	2.10	2.50	0.083	0.098
V	0.45	0.60	0.018	0.024

## NOTES

- Controlling dimension: inches.
- Dimensioning and tolerances per ANSI Y14.5M, 1985.
- Pin 3 is the cathode (Unidirectional Only)
- Dimensions are exclusive of mold flash and metal burrs.

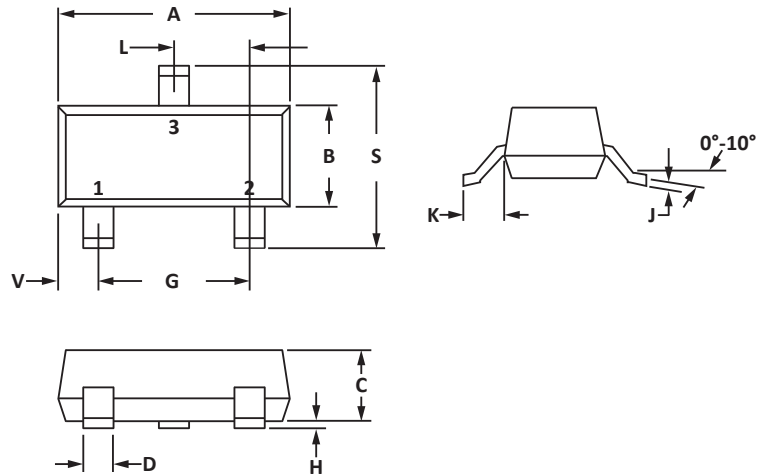

## PAD LAYOUT DIMENSIONS

DIM	MILLIMETERS		INCHES	
	MIN	MAX	MIN	MAX
A	0.71	0.97	0.028	0.038
B	1.88	2.13	0.074	0.084
C	0.71	0.97	0.028	0.038
D	0.81	1.07	0.032	0.042

## NOTES

- Controlling dimension: inches.

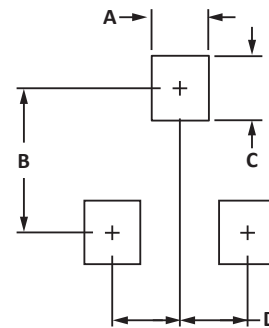

## TAPE AND REEL

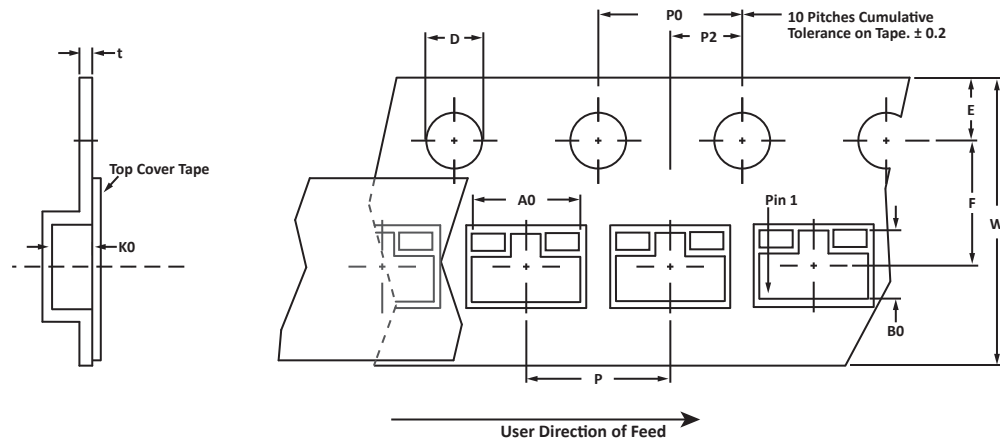

## SPECIFICATIONS

REEL DIA.	TAPE WIDTH	A0	B0	K0	D	E	F	W	P0	P2	P	tmax
178mm (7")	8mm	3.15 ± 0.10	2.77 ± 0.10	1.30 ± 0.10	1.55 ± 0.10	1.75 ± 0.10	3.50 ± 0.05	8.00 ± 0.30	4.00 ± 0.10	2.00 ± 0.05	4.00 ± 0.10	0.228

## NOTES

1. Dimensions are in millimeters.
2. Surface mount product is taped and reeled in accordance with EIA-481.
3. Suffix - T7 = 7" Reel - 3,000 pieces per 8mm tape.
4. Suffix - T13 = 13" Reel - 10,000 pieces per 8mm tape.
5. Marking on Part - marking code (see page 2) and date code.

Package outline, pad layout and tape specifications per document number 06012.R2 8/10.

## ORDERING INFORMATION

BASE PART NUMBER (xx = Voltage)	LEADFREE SUFFIX	TAPE SUFFIX	QTY/REEL	REEL SIZE	TUBE QTY
PSOTxxLC	-LF	-T7	3,000	7"	n/a
PSOTxxLC	-LF	-T13	10,000	13"	n/a

This device is only available in a Lead-Free configuration.

## COMPANY INFORMATION

---

### COMPANY PROFILE

In business more than 25 years, ProTek Devices™ is a privately held semiconductor company. The company offers a product line of overvoltage protection and overcurrent protection components. These include transient voltage suppressor array (TVS arrays) avalanche breakdown diode, steering diode TVS array and electronics SMD chip fuses. These components deliver circuit protection in electronic systems from numerous overvoltage and overcurrent events. They include lightning; electrostatic discharge (ESD); nuclear electromagnetic pulses (NEMP); inductive switching; and electromagnetic interference (EMI) / radio frequency interference (RFI). ProTek Devices also offers LED wafer die for ESD protection and related high frequency products. ProTek Devices is ISO 9001:2015 certified.

### CONTACT US

#### Corporate Headquarters

2929 South Fair Lane  
Tempe, Arizona 85282  
USA

#### By Telephone

General: 602-431-8101  
Sales: & Marketing: 602-414-5109  
Customer Service: 602-414-5114  
Product Technical Support: 602-414-5107

#### By Fax

General: 602-431-2288

#### By E-mail:

Asia Sales: [asiasales@protekdevices.com](mailto:asiasales@protekdevices.com)  
Europe Sales: [europesales@protekdevices.com](mailto:europesales@protekdevices.com)  
U.S. Sales: [ussales@protekdevices.com](mailto:ussales@protekdevices.com)  
Distributor Sales: [distysales@protekdevices.com](mailto:distysales@protekdevices.com)  
Customer Service: [service@protekdevices.com](mailto:service@protekdevices.com)  
Technical Support: [support@protekdevices.com](mailto:support@protekdevices.com)

#### ProTek Devices (Asia Pacific) Pte. Ltd.

8 Ubi Road 2, #06-19  
Zervex  
Singapore - 408538  
Tel: +65-67488312  
Fax: +65-67488313

#### Web

[www.protekdevices.com](http://www.protekdevices.com)

COPYRIGHT © ProTek Devices 1998 - This literature is subject to all applicable copyright laws and is not for resale in any manner.

SPECIFICATIONS: ProTek reserves the right to change the electrical and or mechanical characteristics described herein without notice.

DESIGN CHANGES: ProTek reserves the right to discontinue product lines without notice and that the final judgement concerning selection and specifications is the buyer's and that in furnishing engineering and technical assistance. ProTek assumes no responsibility with respect to the selection or specifications of such products. ProTek makes no warranty, representation or guarantee regarding the suitability of its products for any particular purpose, nor does ProTek assume any liability arising out of the application or use of any product or circuit and specifically disclaims any and all liability without limitation special, consequential or incidental damages.

LIFE SUPPORT POLICY: ProTek Devices products are not authorized for use in life support systems without written consent from the factory.